



**MicroGuard 534**



**Operator's Manual**



---

## NOTICE

SkyAzúl makes no warranty of any kind with regard to this material, including, but not limited to, the implied warranties of merchantability and/or its fitness for a particular purpose.

SkyAzúl will not be liable for errors contained in this manual or for incidental or consequential damages in connection with the furnishing, performance, or use of this manual. This document contains proprietary information, which is protected by copyright, and all rights are reserved.

No part of this document may be photocopied, reproduced, or translated to another language without the prior written consent of SkyAzúl.

SkyAzúl reserves proprietary rights to all drawings, photos and the data contained therein. The drawings, photos and data are confidential and cannot be used or reproduced without the written consent of SkyAzúl. The drawings and/or photos are subject to technical modification without prior notice.

All information in this document is subject to change without notice.



**SkyAzúl, Inc.**  
16 Walnut Street  
Middletown, MD 21769  
Fax 301-371-0029  
[info@skyazul.com](mailto:info@skyazul.com)

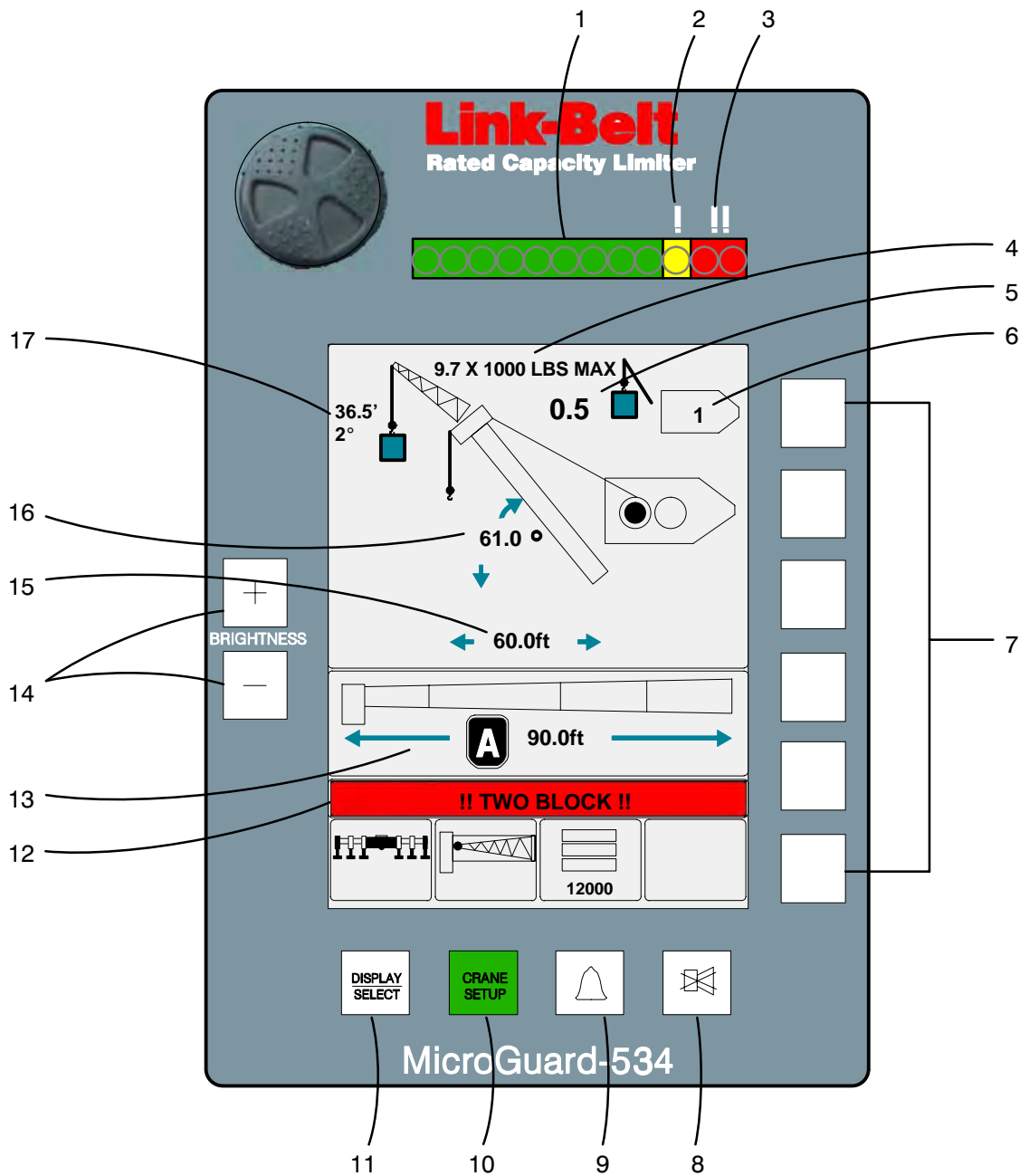


---

**TABLE OF CONTENTS**

<b>CONSOLE LAYOUT AND DESCRIPTION.....</b>	<b>1</b>
<b>SYSTEM DESCRIPTION .....</b>	<b>2</b>
<b>DISPLAY UNIT .....</b>	<b>2</b>
<b>SYSTEM OPERATION .....</b>	<b>4</b>
SYSTEM SELF-TEST .....	4
SYSTEM BYPASS .....	4
CONFIGURATION SELECTION .....	5
NORMAL WORKING SCREEN EXAMPLES .....	9
SELECTION OF RIGGING/TRAVEL MODE.....	11
CANCEL AUDIBLE ALARM AND RESET FUNCTION LIMITERS .....	11
<b>OPERATOR SETTABLE ALARMS.....</b>	<b>11</b>
ANGLE, LENGTH, AND HEIGHT OPERATOR SETTABLE ALARMS .....	12
SWING OPERATOR SETTABLE ALARM .....	13
OPERATOR DEFINED AREA ALARM .....	13
SETTING OPERATOR DEFINED AREA ALARM.....	14
<b>SYSTEM FAULT CODES .....</b>	<b>16</b>
<b>CALIBRATION.....</b>	<b>16</b>






- |                                   |                                    |                                |
|-----------------------------------|------------------------------------|--------------------------------|
| 1. Bar-Graph                      | 7. Configuration Selection Buttons | 13. Boom Length Display        |
| 2. Pre-Alarm Indicator            | 8. Cancel Alarm Button             | 14. Brightness Buttons         |
| 3. Overload Indicator             | 9. Operator Alarms Button          | 15. Load Radius Display        |
| 4. Maximum Rated Capacity Display | 10. Crane Setup Button             | 16. Boom Angle Display         |
| 5. Actual Load Display            | 11. Display/Select Button          | 17. Erected Attachment Display |
| 6. Parts-of-Line Display          | 12. Warning Message Area           |                                |

**Figure 1–68**  
**MicroGuard 534 Rated Capacity Limiter**

## MicroGuard 534 Rated Capacity Limiter

The following describes the function and operation of the Microguard 534 Rated Capacity Limiter. The system is intended to aid the operator in the efficient operation of the crane by continually monitoring the load and warning of an approach to an overload or unsafe condition.



### WARNING

Although the system will alert the operator of an approaching overload or unsafe condition, it remains the responsibility of the operator to operate the crane safely at all times.

This system must never be substituted for the good judgment of the crane operator using safe operating procedures. The operator is solely responsible for safe operation of the crane.

**!!THIS SYSTEM IS AN OPERATOR'S AID – NOT A SAFETY DEVICE!!**

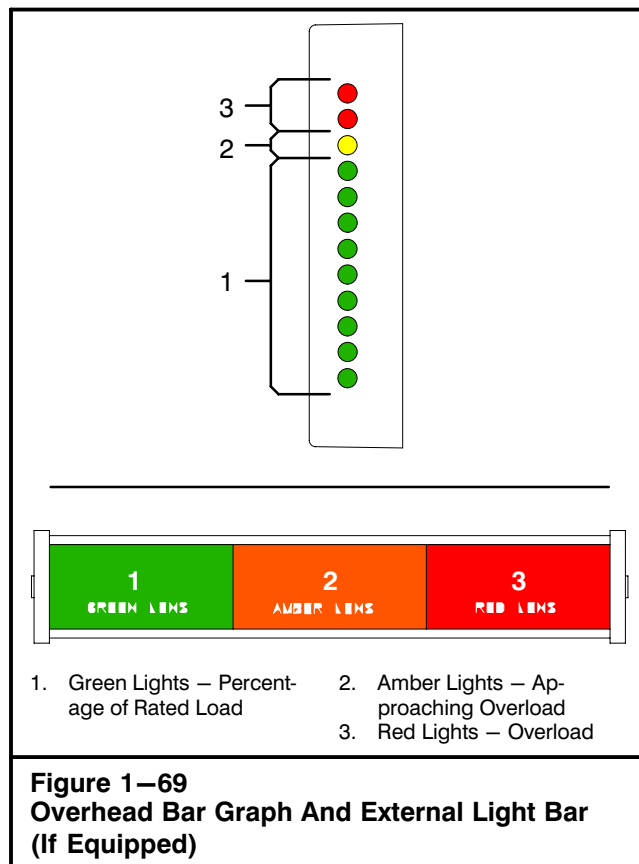
### System Description

The system monitors crane functions by means of high accuracy sensors and continuously compares the load with a copy of the crane capacity chart which is stored in the computer memory. If an overload is approached, the system warns by means of audible and visual alarms and is configured to cause function limitation.

The MicroGuard 534 Rated Capacity Limiter provides the operator with a continuous display of:

- Rated Capacity
- Actual Load
- Percentage of Rated Capacity
- Radius of the Load
- Angle of the Main Boom
- Crane Configuration
- Length of the Main Boom

An additional feature of the system is the provision of operator settable alarms. These alarms, when properly set, provide a method of obstacle avoidance. This is achieved by means of maximum boom angle, maximum load radius, maximum boom head height, left and right swing, and defined area alarms. These alarms can be programmed for each job site and set rapidly for the prevailing site conditions thereby aiding the operator in safe operation of the crane.



### Display Unit

The following is a description of the control buttons, indicators, and windows on the display unit. Use them along with Figure 1–68.

#### 1. Bar-Graph

The Bar-Graph is a series of twelve colored lights which gives a visual indication of how much of the crane's capacity is being used and the rate at which an overload is being approached. Each green light represents 10% of the crane's rated capacity is being used. Yellow indicates 90–99.9%, and the red lights indicate an overload.

**Note: System may be equipped with an overhead bar graph or an external light bar which operates similar to the bar graph on the display. Refer to Figure 1–69.**

#### 2. Pre-Alarm indicator

The Pre-Alarm (yellow) Indicator illuminates at a pre-set value of 90% of Maximum Rated Capacity and provides a visual indication of an approach to an overload.



### 3. Overload Indicator

The Overload Indicator (red) illuminates at a pre-set value of 100% of Maximum Rated Capacity and provides a visual indication of Maximum Allowed Load. It will also illuminate whenever a wire rope limit is exceeded. Function limiters will occur simultaneously for an Overload, Wire Rope Limit, or a Two Block condition but function limiters will not occur when exceeding an operator settable alarm. An audible alarm will sound and a message will appear in the warning message area for all 4 conditions.

### 4. Maximum Rated Capacity Display

The Maximum Rated Capacity is a digital display of the maximum permitted capacity. It is derived from a copy of the crane's capacity chart which is stored in the computer memory and is the reference capacity for any lifting operation. It is dependent on the configuration currently selected, which is shown in the crane setup screen, and which determines the section of the capacity chart to be used as the rated capacity reference.

### 5. Actual Load Display

The Actual Load Display is a digital display which shows total load suspended below the boom or fly head. It includes the load, any slings, pins, or tackle used to secure the load and the hook block or ball.

### 6. Parts-of-Line Display

Parts-of-Line displays the parts of line currently selected for the winch in use.

### 7. Configuration Selection Buttons

These buttons are used during the crane configuration selection routine. Refer to "Configuration Selection" found later in this Section of the Operator's Manual.

### 8. Cancel Alarm Button

This button is used to silence the audible alarm when the alarm has occurred as a result of either an Overload, Wire Rope Limit, a Two Block, or an Operator Settable alarm. It is also used to reset the function limit relay when it is necessary to by-pass function limit which has occurred as a result of either an Overload, Wire Rope Limit, or a Two Block alarm.

### 9. Operator Alarms Button

This button is used to start the operator settable alarms routines. Refer to "Operator Settable Alarms" found later in this section of the Operator's Manual.

### 10. Crane Setup Button

This button is used to start the configuration selection routine. Refer to "Configuration Selection" found later in this Section of the Operator's Manual.

### 11. Display/Select Button

This button is used to access the Calibration And Diagnostic Screen. Refer to "System Fault Codes" and "Calibration" found later in this Section of the Operator's Manual.

### 12. Warning Message Area

The Warning Message Area displays text messages of various alarms which may occur during normal operation of the system. When an alarm occurs, the rectangular area fills in red.

### 13. Boom Length Display

The Boom Length Display gives a continuous indication of the boom length in feet (*m*). It is the distance from the centerline of the boom foot pin to the center line of the boom head machinery.

### 14. Brightness Buttons

These buttons are used to adjust the display brightness.

### 15. Load Radius Display

The Load Radius Display gives a continuous indication of the radius of the load in feet (*m*). It is the horizontal distance from the centerline of rotation to the centerline of the hook.

### 16. Boom Angle Display

The Boom Angle Display gives a continuous indication of the angle of the main boom relative to horizontal.

### 17. Erected Attachment Display

The Erected Attachment Display gives a continuous display of the erected attachment with the top number indicating the actual fly length and the bottom number indicating the offset angle if applicable.

## System Operation

The following is a list of procedures which are used to operate the multiple features of the Rated Capacity Limiter. Use these procedures in conjunction with the previous display unit control descriptions.

### System Self-Test

At start-up the system automatically performs a self test after which all lamps, audible alarms, and digital displays will be functionally tested and all memory areas checked for accuracy. If faults in the system are detected during a test, the warning message area will show the words SYSTEM FAULT. If the words SYSTEM FAULT occur, press the Display/Select button to display the Calibration And Diagnostic screen. Through the Calibration And Diagnostic screen, information can be accessed about the fault condition by means of an error code. Contact your local distributor for details of the fault codes.

**Note:** If the batteries have been disconnected interrupting power to the computer, the start-up time for on-board computer systems will be longer than normal.

### System Bypass

In emergency situations, the Rated Capacity Limiter computer can be bypassed. The computer is located on the back of the operator's cab. Refer to Figure 1–70. There is a RCL Status keyswitch adjacent to the computer to bypass the system. Move the key to the "Bypass" position to bypass the system. For emergency use while the system is bypassed, refer to "System Inoperative or Malfunctioning" that follows.



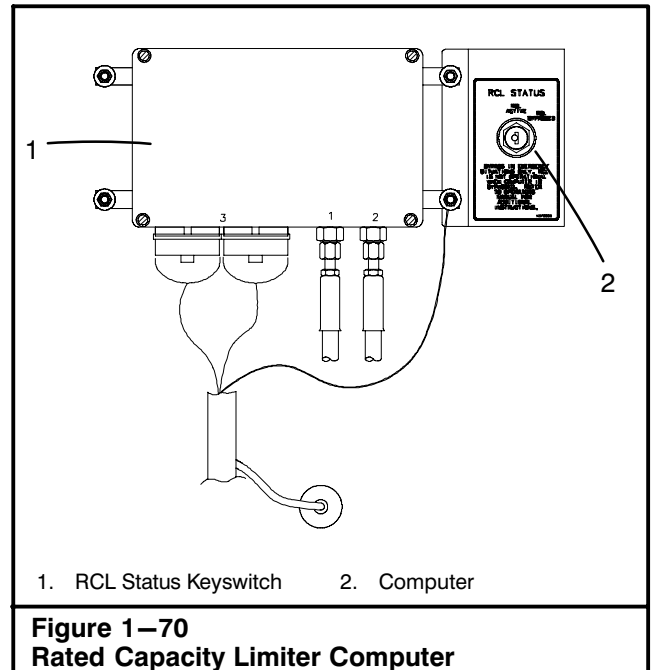
## WARNING

**The Microguard 534 is not operational when the computer is bypassed. Bypass the system in emergency situations only.**

### System Inoperative Or Malfunctioning

When operational aids are inoperative or malfunctioning, the following recommendations for continued use of the crane should be followed or the crane should be shutdown.

1. Steps shall be taken to schedule repairs and recalibration immediately. The operational aids shall be put back into service as soon as replacement parts, if required, are available and the repairs and recalibration can be carried out. Every reasonable effort must be made to expedite the repairs and recalibration.



**Figure 1–70**  
**Rated Capacity Limiter Computer**

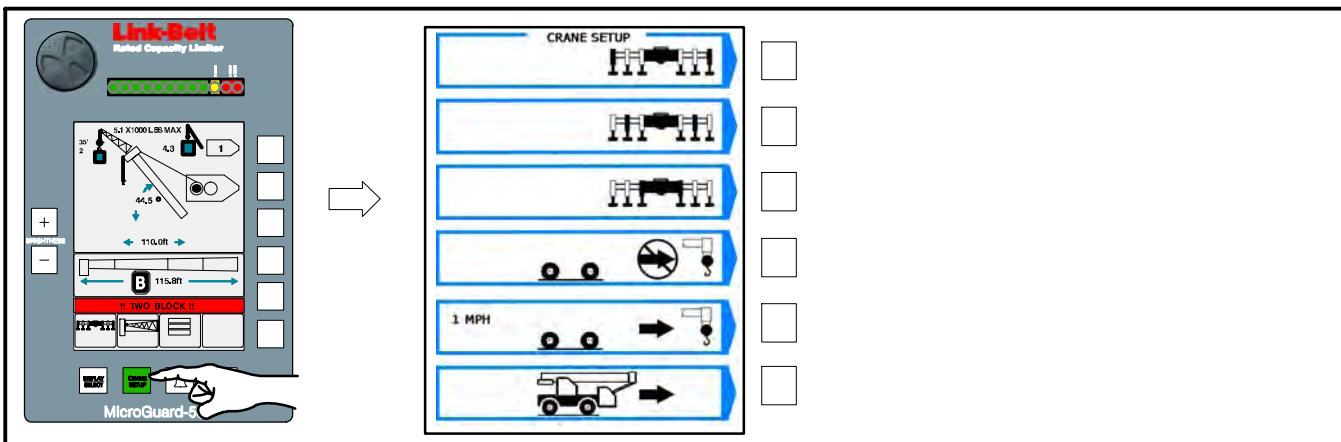
2. When the rated capacity limiter is inoperative or malfunctioning, the designated person responsible for supervising the lifting operations shall establish procedures for determining load weights and shall ascertain that the weight of the load does not exceed the crane ratings at the radius where the load is to be handled.
3. When a boom angle or radius indicator is inoperative or malfunctioning, the radius or boom angle shall be determined by measurement.
4. When the anti-two block warning device is inoperative or malfunctioning, the designated person responsible for supervising the lifting operations shall establish procedures, such as assigning an additional signal person, to furnish equivalent protection. This does not apply when lifting personnel in load line supported baskets. Personnel shall not be lifted in load line supported baskets when the anti-two block devices are not functioning properly.
5. When a boom length indicator is inoperative or malfunctioning, the designated person responsible for supervising the lifting operations shall establish the boom length at which the lift will be made by actual measurement or markings on the boom.
6. When a level indicator is inoperative or malfunctioning, other means shall be used to level the crane.
7. In situations where inconsistency exists, verified weights, measured radii, boom lengths, and authorized crane capacities must always take precedence over indicator readings.

## Configuration Selection

In the normal operational mode the system is programmed to remember the last configuration selected. Each time the system is powered up it will automatically default to that configuration. Only when the crane is rigged differently must a new configuration be selected. Use the following procedure to select the crane configuration.

**Note:** When selecting configurations allowed on outriggers, all beams must be equally extended; all fully retracted, intermediate extended, or fully extended.

Depending on how the crane is equipped or which selections have been made, some screens shown may not appear or may not appear as illustrated. The system cannot be programmed for configurations not allowed by the capacity charts listed in the Crane Rating Manual.



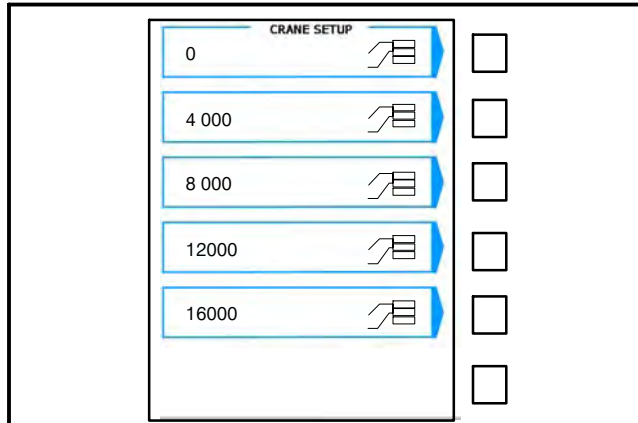
**Figure 1-71**  
**Carrier Selection**

1. From the normal working screen press the CRANE SETUP button. The normal working screen will change and graphically display the carrier options. Press the corresponding configuration selection button to select the desired carrier configuration. If rigging is desired, refer to “To Select Rigging/Travel Mode” found later in this Section of the Operator’s Manual.



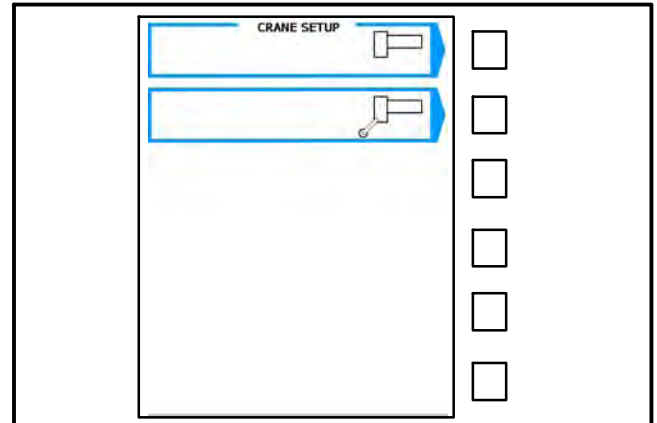
## WARNING

The Microguard 534 is not operational when in the RIGGING/TRAVEL Mode. Return the Microguard 534 to normal operation before operating the crane.



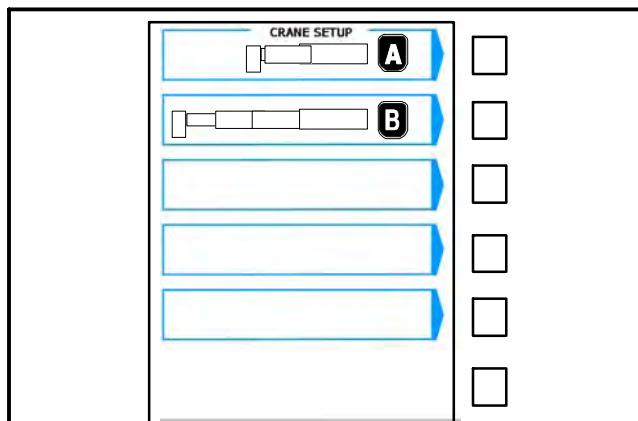
**Figure 1-72**  
**Counterweight Selection**

- The carrier selection screen will change and graphically display the counterweight options. Press the corresponding configuration selection button to select the installed counterweight.



**Figure 1-74**  
**Auxiliary Head Selection**

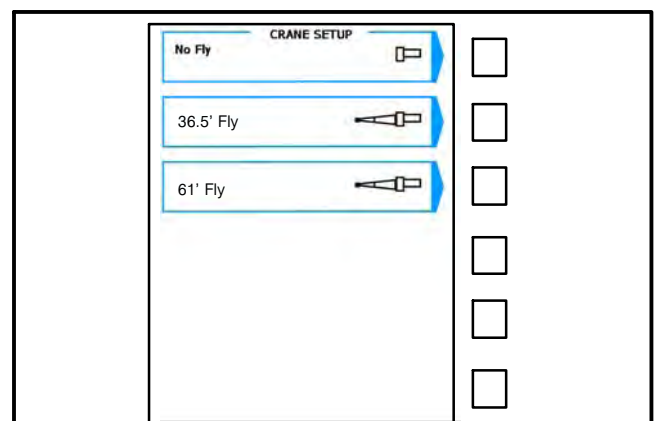
- The boom mode selection screen will change and graphically display the auxiliary lifting sheave fitted or not fitted. Press the corresponding configuration selection button to select the actual auxiliary lifting sheave configuration.



**Figure 1-73**  
**Boom Extend Mode Selection**

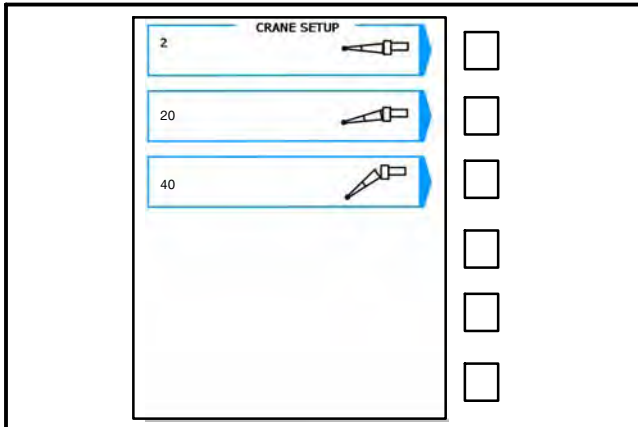
- The counterweight selection screen will change and graphically display the boom mode options. Press the corresponding configuration selection button to select the desired boom mode.

**Note:** Consult the Crane Rating Manual to determine the best boom mode to maximize lift capacity at working radius. Boom mode options will only be displayed when the boom is fully retracted.

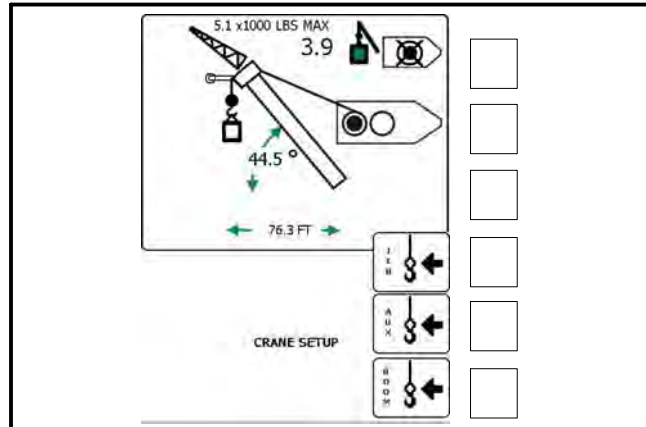


**Figure 1-75**  
**Erected Attachment Selection**

- If the crane is equipped with a fly, the auxiliary sheave selection screen will change and graphically display an erected attachment. Press the corresponding configuration selection button to select the installed erected attachment if required.



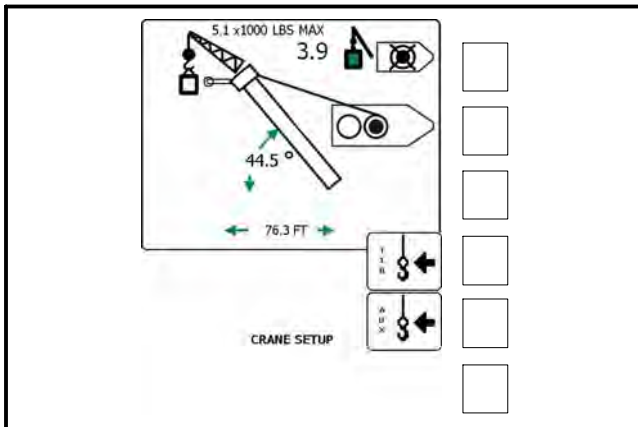
**Figure 1-76**  
Erected Attachment Offset Selection



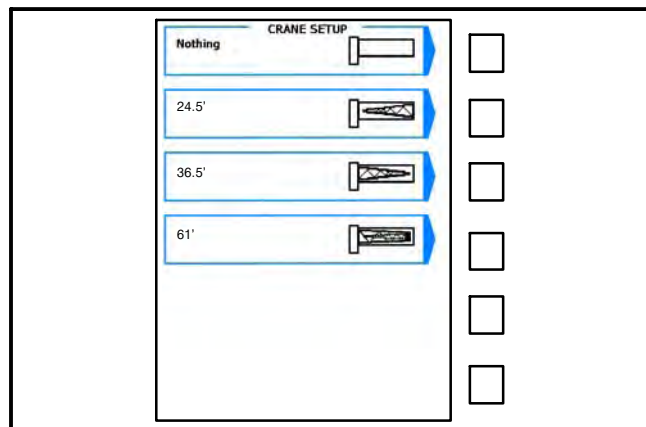
**Figure 1-78**  
Front Winch Lifting Point Selection

6. If an offset fly was previously selected, the erected attachment selection screen will change and graphically display the available offset angles. Press the corresponding configuration selection button to select the installed offset angle if required.

8. If the crane is equipped with a front winch, the rear winch lifting point screen will change and graphically display the front winch lifting point. Press the corresponding configuration selection button to select the actual front winch lifting point. Or press the corresponding configuration selection button to select the front winch not in use.



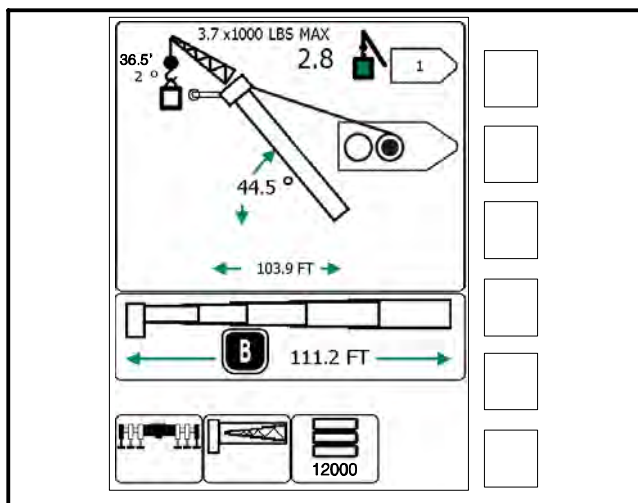
**Figure 1-77**  
Rear Winch Lifting Point Selection



**Figure 1-79**  
Stowed Attachment Selection

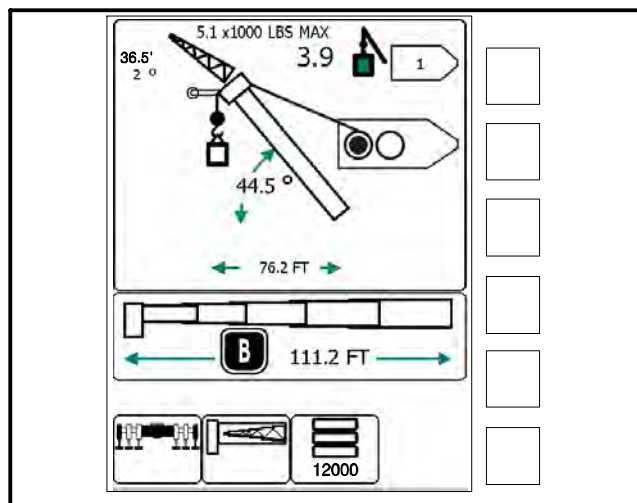
7. The erected attachment or erected attachment offset selection screen will change and graphically display the rear winch lifting point. Press the corresponding configuration selection button to select the actual rear winch lifting point. Or press the corresponding configuration selection button to select the rear winch not in use.

9. If the crane is equipped with a fly and was not selected as an erected attachment, the winch lifting point screen will change and graphically display the stowed attachment. Press the corresponding configuration selection button to select the actual stowed attachment if required.



**Figure 1-80**  
Rear Winch Parts Of Line Selection

10. The crane setup screen will change to the normal working screen and graphically display the crane configuration as previously selected. Press the corresponding configuration selection button to select the actual parts of line for the rear winch.



**Figure 1-81**  
Front Winch Parts Of Line Selection

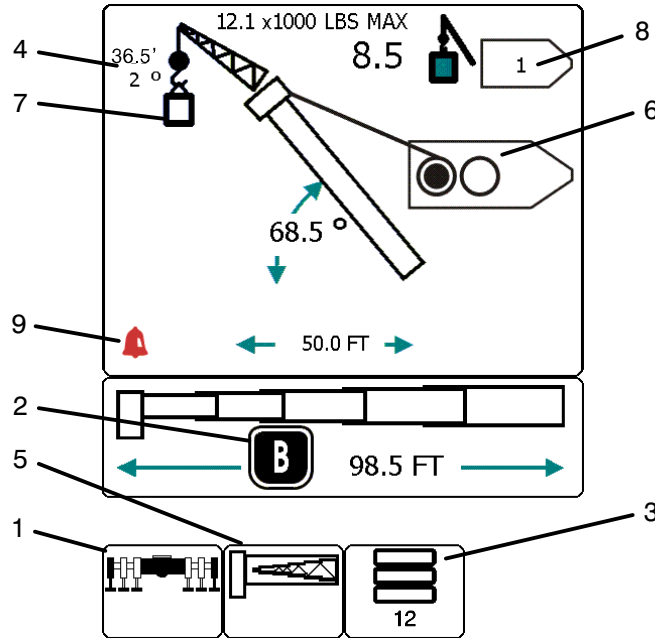
11. If the crane is equipped with a front winch and it was selected, press the corresponding configuration selection button to select the front winch. Press the corresponding configuration selection button to select the actual parts of line for the front winch.

**Note:** From the normal working screen, after crane setup has been established, only two selection buttons are active; the winch select button and the parts of line button.

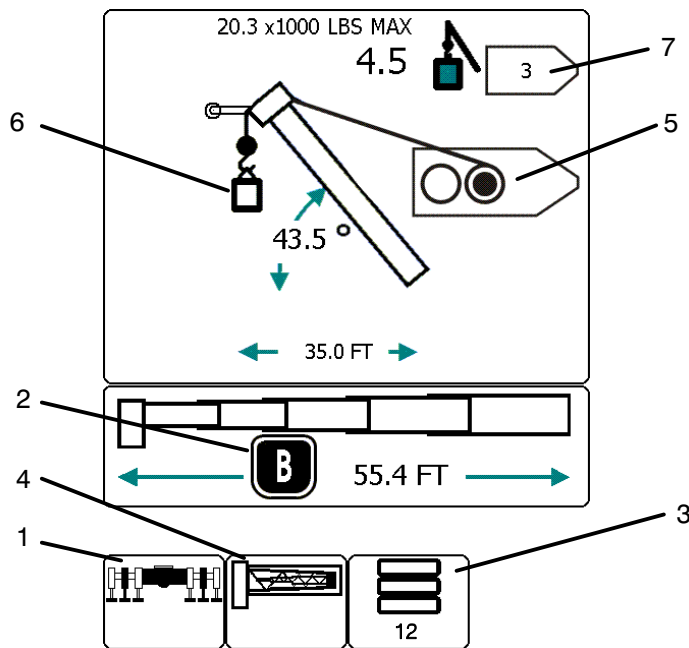
To change winches, push the winch select button to toggle between winches. The winch lifting points cannot be changed without going through the crane setup routine.

The parts of line can be changed for the selected winch by pressing the parts of line button to scroll through the available options for that winch.

Refer to Figure 1-82 and Figure 1-83 for examples of some normal working screens.

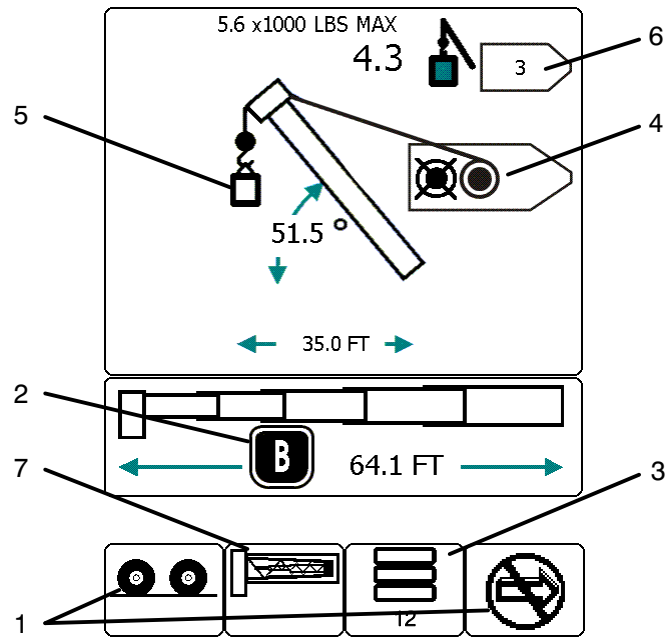


In this example the crane is setup on fully extended outriggers (1), boom mode B (2), 12,000 lb counterweight (3), 36.5' fly base erected at 2 degree offset (4), fly tip stowed (5), the rear winch available with the main boom head and the front winch selected (6), with the winch rope reeved over the fly base (7), with one part of line (8), and an operator settable alarm enabled (9).

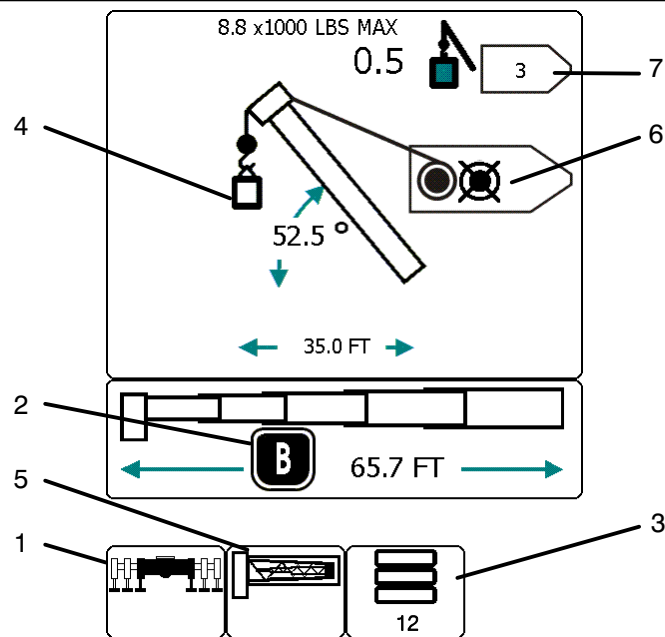


In this example the crane is setup on intermediate extended outriggers (1), boom mode B (2), 12,000 lb counterweight (3) 61' fly stowed (4), the front winch available with the auxiliary head and the rear winch selected (5), with the winch rope reeved over the main boom head (6) with three parts of line (7).

**Figure 1–82**  
**Normal Working Screen Examples**



In this example the crane is setup for stationary on tires (1), boom mode B (2), 12,000 lb of counterweight (3), front winch not in use and the rear winch selected (4), winch rope reeved over the main boom (5), with three parts of line (6), and the 61' fly stowed (7).



In this example the crane is setup on fully retracted outriggers (1), boom mode B (2), 12,000 lb of counterweight (3), winch rope reeved over the main boom (4), 61' fly stowed (5), rear winch not in use and the front winch selected (6), with three parts of line (7).

**Figure 1–83**  
Normal Working Screen Examples



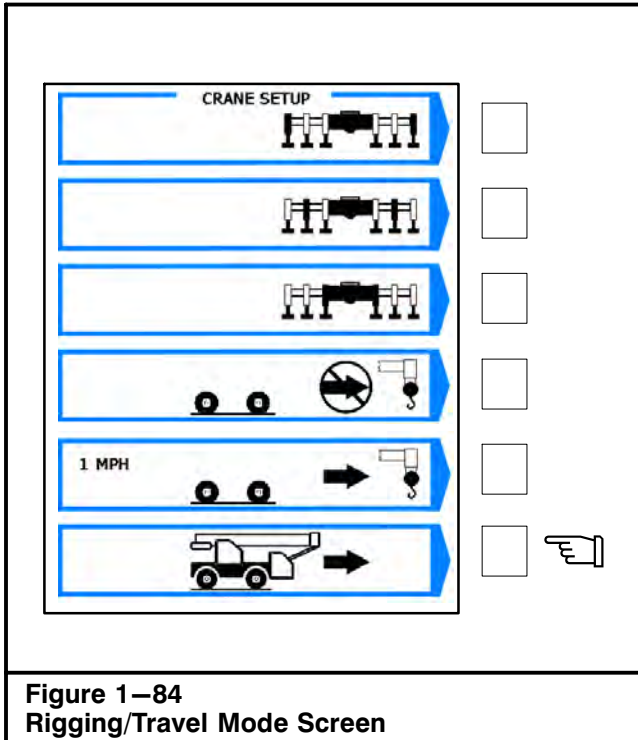




Figure 1-84  
Rigging/Travel Mode Screen

**To Select Rigging/Travel Mode**

The CRANE SETUP push button is also used to select RIGGING/TRAVEL MODE. This mode is used to facilitate rigging and travel of the crane by inhibiting function limiters and the audible alarm while selected. To resume crane operation, select proper outrigger or tire configuration per the proper procedure.


 **WARNING**


**The Microguard 534 is not operational when in the RIGGING/TRAVEL Mode. Return the Microguard 534 to normal operation before operating the crane.**

1. From the normal working screen press the CRANE SETUP button. The crane setup screen will change and graphically display the carrier options.
2. Select  for stationary rigging or when traveling the crane. Refer to Figure 1-84.

**Note: Boom must be fully retracted to enter travel mode.**

**Cancel Audible Alarm And Reset Function Limiters**

The CANCEL ALARM button  is used to cancel the audible alarm when the alarm has occurred as a result of either an Overload, a Two Block alarm, or an Operator settable alarm. The audible alarm may be canceled by pressing and releasing the CANCEL ALARM button. The audible alarm remains canceled until the condition which caused the alarm has been removed. For example, if the audible alarm was canceled because of an overload condition, it will remain canceled until the overload condition is removed. However, if a different alarm, e.g. two block condition, was to occur when the audible alarm was still canceled for an earlier overload condition, the new alarm condition would cause the audible alarm to be re-started.

 **WARNING**

**Once the function limiters have been by-passed, the crane is no longer protected against the condition that initially caused the function limiters to occur.**

**Note: The CANCEL ALARM feature is a temporary function. The audible alarm or function limit is automatically reset when the condition which caused the alarm is no longer present.**

The CANCEL ALARM is also used to reset the function limiters when it is necessary to by-pass the function limiters which has occurred as a result of either an overload, a two block alarm, or a rope limit. Function limiters are reset by first canceling the audible alarm (as described above) and then pressing and holding the CANCEL ALARM button for about 3 seconds, after which the function limiters will be reset to allow normal operation. However, should another different alarm condition occur when the function limiters had previously been over-ridden, then the newly occurring alarm condition would cause the function limiters to activate again.

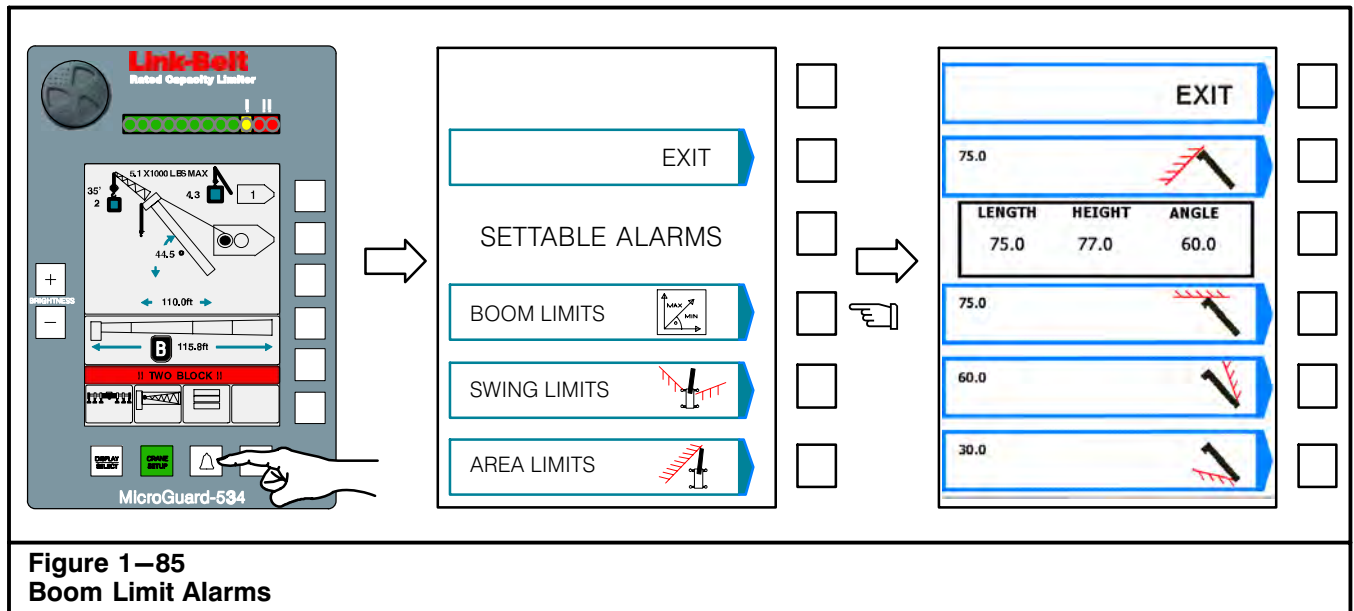
**Operator Settable Alarms**

Some alarms occur automatically as a result of limitations imposed by the capacity chart. The operator has control over additional alarms which can be set to operate within the normal chart limitations and which are, in addition to, those already set by the chart.

Operator settable alarms will be stored in the computer memory, even if the crane is shutdown, until they are cleared. Refer to Figure 1-85.

Alarms available for operator use are:

- |                    |                       |
|--------------------|-----------------------|
| Minimum Boom Angle | Maximum Boom Length   |
| Maximum Boom Angle | Left and Right Swing  |
| Maximum Tip Height | Operator Defined Area |



**WARNING**

The operator settable alarms are a warning device. All functions remain operational when entering the operator defined bad area. For safe operation, adequate distance must be maintained to allow for operator reaction time to avoid entering the bad area. It is the responsibility of the operator to set points which ensure that the crane's boom, attachment, load, rigging, etc. maintains a safe working distance and complies with local safety regulations.

**Angle, Length, And Height Operator Settable Alarms**

1. From the normal working screen press OPERATOR ALARM button to access the Settable Alarms screen.
2. Press the corresponding button for Boom Limits .

**WARNING**

Avoid positioning the boom, attachment, load, rigging, etc. into the bad area when setting the alarm values.

When selecting the alarm values, ensure that the load will maintain a safe distance from the obstacle.

3. Position the boom in the desired position depending upon the alarm to be set. The numerical value displayed will be the current position of the boom.

4. Press the corresponding selection button to set the desired alarm value as defined below. Press the button again to turn alarm off.

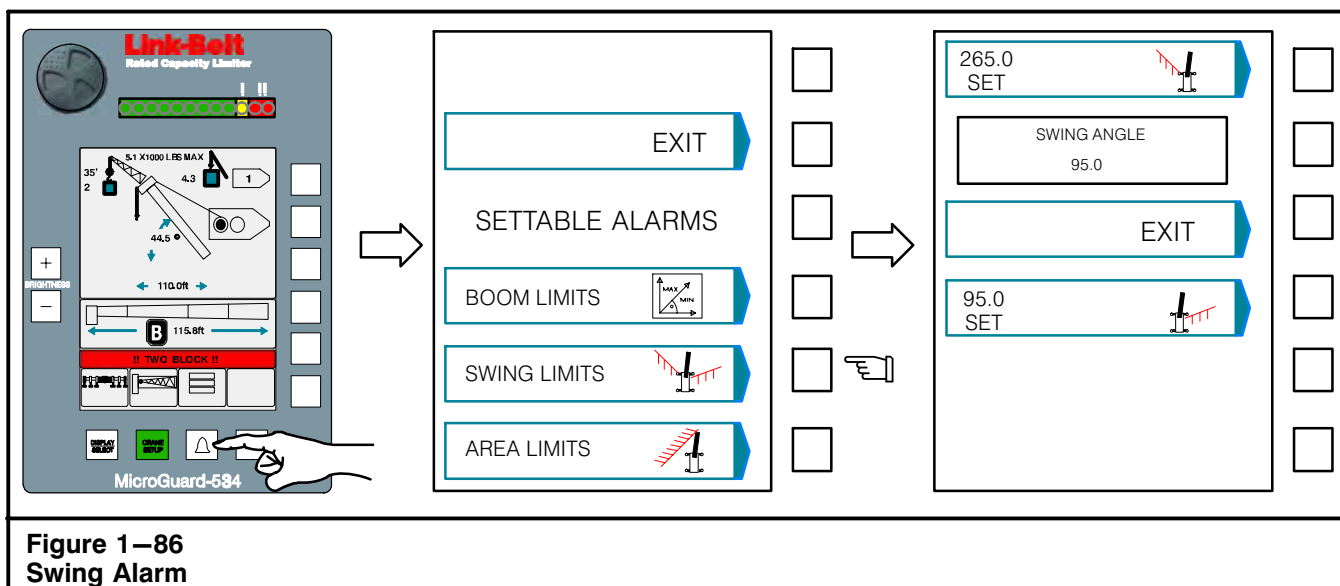
	Maximum Boom Length
	Maximum Tip Height
	Maximum Boom Angle
	Minimum Boom Angle

5. When all alarm values are set, press the EXIT button to return to the alarm screen. At the Settable Alarm screen, press the EXIT button again to return to the normal working screen.
6. Test the alarm, with no load, to ensure the alarm points have been properly set. When approaching the alarm set point, the audible will sound intermittently and a warning message will appear in the warning message area. When exceeding the alarm set point, the audible alarm will sound continuously and a warning message will appear in warning message area.

**Note:** An alarm icon will appear on the normal working screen to alert the operator that an operator alarm has been set.

**WARNING**

If crane or obstacle is moved or if a different size load is lifted, the alarm(s) must be reset.



**Figure 1–86**  
**Swing Alarm**

### Swing Operator Settable Alarm

To have an alarm whenever the left swing and right swing exceed pre-determined alarm points, use the following procedure:

1. From the normal working screen press OPERATOR ALARM button to access the Settable Alarms screen.
2. Press the corresponding button for Swing Limits .
3. Swing the boom to the left alarm point .
4. Press the corresponding button for Left Swing to enter the left alarm point. The displayed value will be the left alarm setting.
5. Swing the boom to the right alarm point.
6. Press the corresponding button for Right Swing to enter the right alarm point. The displayed value will be the right alarm setting.
7. Press the EXIT button to return to the settable alarm screen. Press the EXIT button on the settable alarms screen to return to the normal working screen.
8. Test the alarm, with no load, to ensure the alarm points have been properly set. When approaching the set alarm point, the audible alarm will sound intermittently and “Swing Alarm” will appear in the warning message area. The audible alarm will activate whenever the swing exceeds the alarm points and “Swing Alarm” will appear in warning message area.

**Note:** Both the left and right swing alarms must be set for the system to determine the operator set working area.

**Note:** An alarm icon will appear on the normal working screen to alert the operator that an operator alarm has been set.

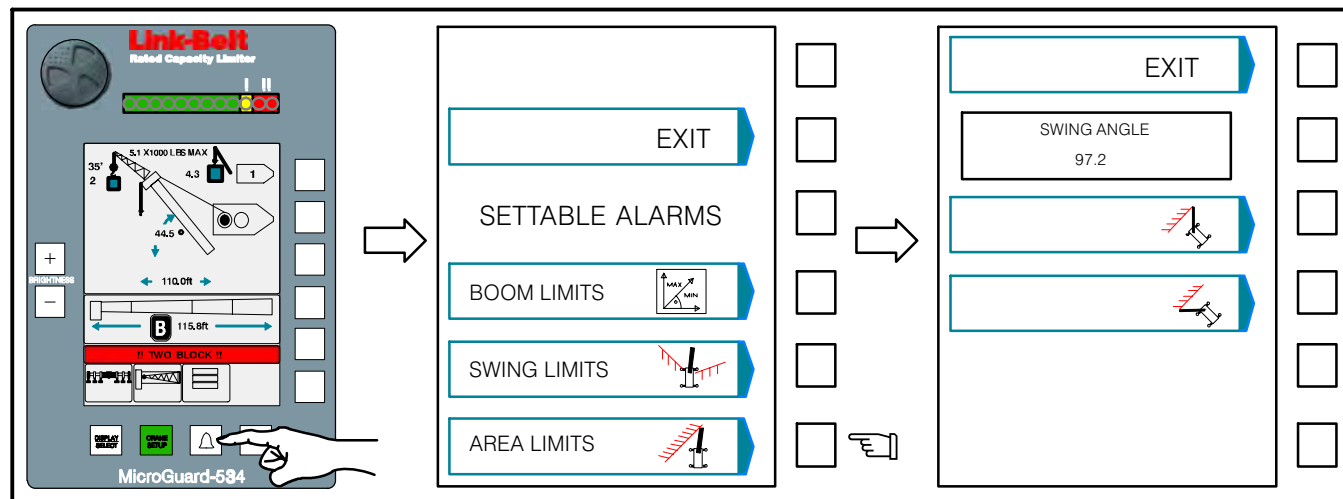
### Operator Defined Area Alarm

The operator defined area alarm, when set, will define an imaginary vertical plane between two set points to optimize the working area. When approaching the plane, the audible alarm will sound intermittently, and the message “Bad Working Area” will appear in the warning message area. When passing the plane, the audible alarm will sound continuously and the message “Bad Working Area” will appear on the warning message area. Use the following procedure, Figure 1–87, and Figure 1–88 to set the operator defined area alarm.



## WARNING

The operator defined area alarm is a warning device. All functions remain operational when entering the operator defined bad area. For safe operation, adequate distance must be maintained to allow for operator reaction time to avoid entering the bad area. It is the responsibility of the operator to set points which ensure that the crane's boom, attachment, load, rigging, etc. maintains a safe working distance and complies with local safety regulations.



**Figure 1–87**  
**Operator Defined Area Alarm**

**Setting Operator Defined Area Alarm**

1. From the normal working screen press OPERATOR ALARM button to access the Settable Alarms screen.
2. Disable any previously set left and right swing alarms if required.

**Note:** The left and right swing alarms must be cleared prior to setting the defined area alarm.

3. Press the corresponding button for Area Limit .

**WARNING**

**Avoid positioning the boom, attachment, load, rigging, etc. into the bad area when setting the left or right alarm points.**

**When selecting the left and right alarm points, ensure that the load will maintain a safe distance from the obstacle. Also ensure that the two points are set so that the tailswing of the crane will not enter the bad area.**

4. Position the boom, attachment, load, rigging, etc. to the right alarm point and press the corresponding button to enter the right alarm point. The displayed value will be the right alarm setting.
5. Position the boom, attachment, load, rigging, etc. to the left alarm point and press the corresponding

button to enter the left alarm point. The displayed value will be the left alarm setting.

**Note:** For best results, the two points should be separated by a minimum of 10 ft (3m) or 30 degrees.

6. When both alarm points are set, press the EXIT button to return to the settable alarms screen. Press the EXIT button on the settable alarms to return to the normal working screen.
7. Test the alarm, with no load, to ensure the alarm points have been properly set. When approaching the plane, the audible alarm will sound intermittently and the message “Bad Working Area” will appear on the warning message area. When passing the plane, the audible alarm will sound continuously and the message “Bad Working Area” will appear on the warning message area.

**WARNING**

**If crane or obstacle is moved or if a different size load is lifted, the area alarm must be reset.**

**Note:** An alarm icon will appear on the normal working screen to alert the operator that an operator alarm has been set.

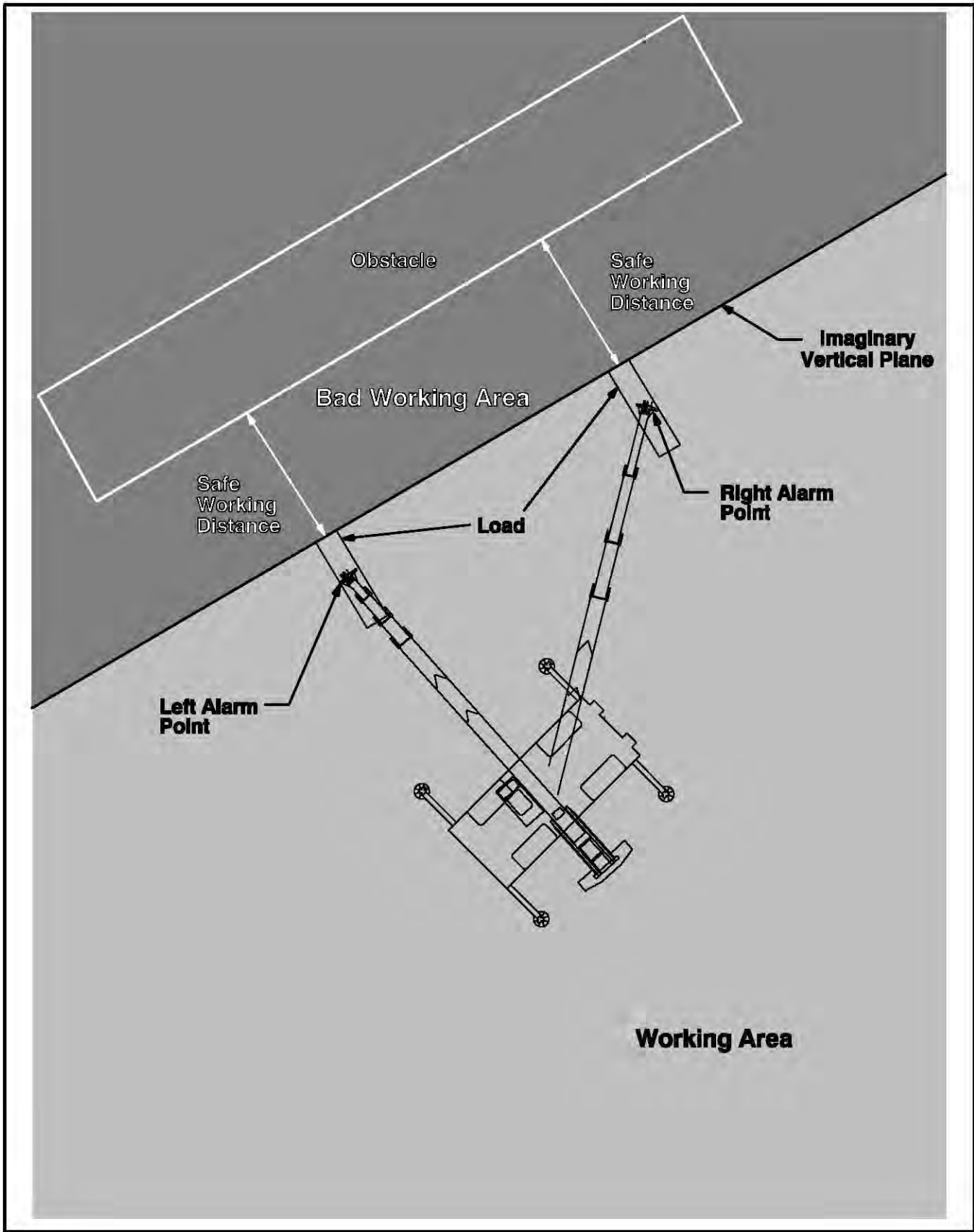
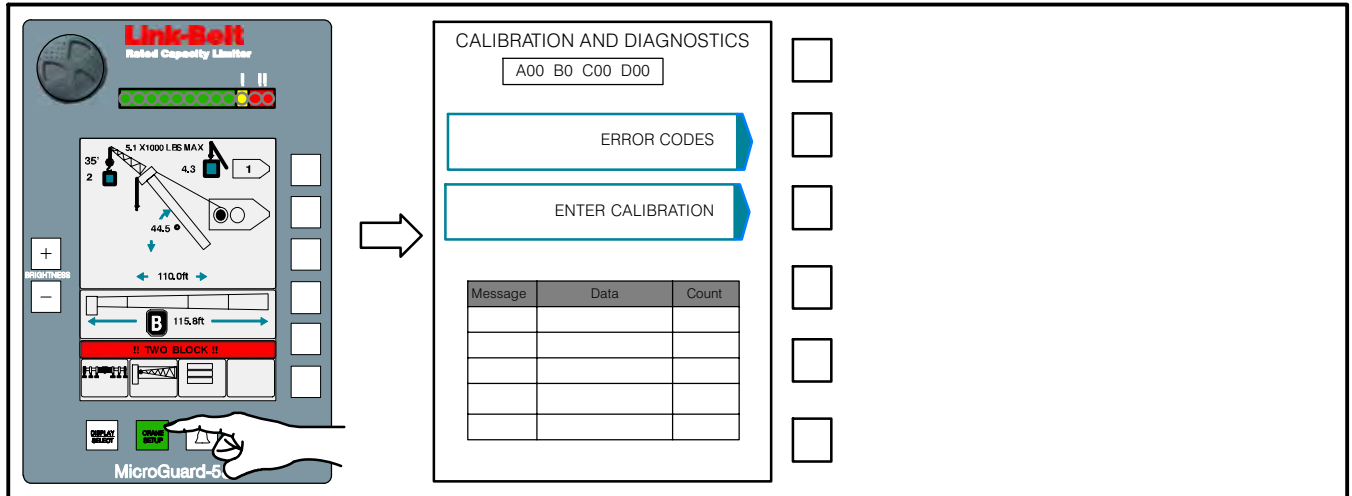


Figure 1-88  
Operator Defined Area Alarm



**Figure 1–89**  
**Calibration And Diagnostic Screen**

**System Fault Codes**

If faults in the system are detected during a test, the warning message area will show the words SYSTEM FAULT. If the words SYSTEM FAULT occur, press the Display/Select button to display the Calibration And Diagnostic screen. On the Calibration And Diagnostic screen, press the Error Code button to display error codes in the box at the top of the screen. This information can then be used to assist the service technician in determining the fault. Contact your distributor for assistance with the fault codes.

**Calibration**

If the system requires calibration, contact your distributor for assistance. Calibration must be done by a qualified technician. Press the Display/Select button to display the Calibration And Diagnostic screen. On the Calibration And Diagnostic screen, press the Enter Calibration button. The calibration screen will be displayed and prompt a calibration key sequence to begin the calibration routine.





[www.skyazul.com](http://www.skyazul.com)

**SkyAzul, Inc.**

16 Walnut Street  
Middletown, MD 21769  
Phone 301-371-6126  
Fax 301-371-0029  
[info@skyazul.com](mailto:info@skyazul.com)